



# INJECTA

the perfect dosing

WATER TREATMENT DIVISION  
SWIMMING POOL DIVISION  
INDUSTRIAL DIVISION



# CATALOGUE

# 2022

[www.injecta.com](http://www.injecta.com)





# TAURUS SERIES

POMPE DOSATRICI ELECTROMECCANICHE - ELECTROMECHANIC DOSING PUMPS



## CARATTERISTICHE GENERALI / GENERAL FEATURES

- Il meccanismo di queste pompe è del tipo ad eccentrico e piattello con ritorno a molla, racchiuso da un carter di alluminio in bagno d'olio
- Di serie la regolazione della pompa è manuale, ma è possibile comandarla con un segnale remoto, tramite servocomando elettrico con un segnale 4÷20 mA o inverter

- These pumps are plunger piston metering pumps with a spring return stroke, fitted in an alluminium housing with oil bath
- The pump can be manually adjusted, but it is possible to work it through a remote signal, thanks to an electric servo control with a 4÷20 mA signal, or an inverter

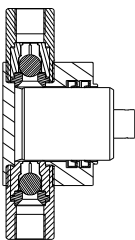

### VERSIONE CON PISTONE / PISTON VERSION

- **Testata pompante di serie in AISI316 o in PVC**
- **Pistone in AISI316 o ceramica**

- SS316 or PVC pump head
- SS316 or ceramic piston

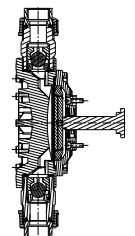

### VERSIONE CON DIAFRAMMA / DIAPHRAGM VERSION

- **Testata pompante di serie in AISI316, PP, PVDF e PVC**
- **Membrana in PTFE**

- SS316, PP, PVDF or PVC pump head
- PTFE diaphragm

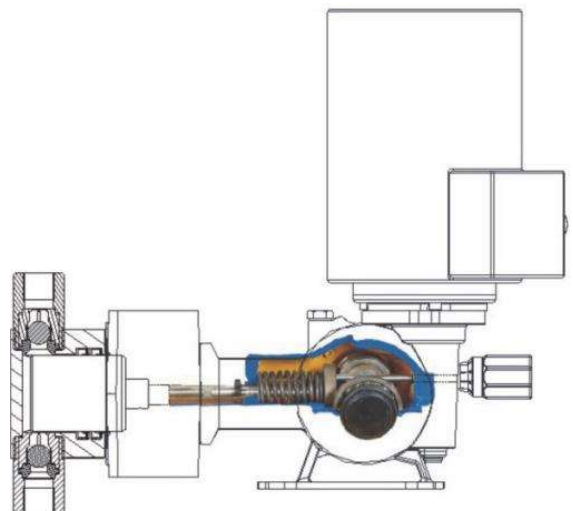



# TAURUS SERIES

POMPE DOSATRICI ELECTROMECCANICHE - ELECTROMECHANIC DOSING PUMPS



## TP VERSIONE CON PISTONE - PISTON VERSION

### CORSA 15 mm.

- Portata massima 1,5÷304 lt/h
- Pressione massima 20 bar
- Frequenza fissa 58-116 colpi/min
- Diametro pistone 6÷24 mm.
- Motori 0,18/0,25 kW di tipo unificato IP55

### STROKE 15 mm.

- 1,5÷304 l/h max flow rate
- 20 bar max pressure
- 58-116 strokes/min. fixed frequency
- 6÷24 mm. piston diameter
- 0,18/0,25 kW standard IP55 motors



# TAURUS SERIES

POMPE DOSATRICI ELECTROMECCANICHE - ELECTROMECHANIC DOSING PUMPS

TP 15 VERSIONE CON PISTONE - PISTON VERSION								
MODELLI MODELS	Ø PISTONI Ø PISTONS	COLPI/min. STROKES/min.	PORTATE FLOW RATES	PRESSIONI - PRESSURES SS316 PVC	CONNESSIONI CONNECTIONS	PESI - WEIGHTS SS316	PVC	
TRIFASE - THREE-PHASE 0,18 kW - MONOFASE - SINGLE-PHASE 0,25 kW								
TP 15 006A	6 mm	58	1,5 lt/h	20 bar	10 bar	1/4 g.f.	9,8 kg	8,4 kg
TP 15 006C	6 mm	116	3,0 lt/h	20 bar	10 bar	1/4 g.f.	9,8 kg	8,4 kg
TP 15 011A	11 mm	58	5,0 lt/h	20 bar	10 bar	1/4 g.f.	9,8 kg	8,4 kg
TP 15 011C	11 mm	116	10,0 lt/h	25 bar	10 bar	1/4 g.f.	9,8 kg	8,4 kg
TP 15 017A	17 mm	58	11,0 lt/h	20 bar	10 bar	3/8 g.f.	9,8 kg	8,4 kg
TP 15 017C	17 mm	116	22,0 lt/h	25 bar	10 bar	3/8 g.f.	9,8 kg	8,4 kg
TP 15 025A	25 mm	58	25,0 lt/h	20 bar	10 bar	3/8 g.f.	9,8 kg	8,4 kg
TP 15 025C	25 mm	116	50,0 lt/h	20 bar	10 bar	3/8 g.f.	9,8 kg	8,4 kg
TRIFASE - THREE-PHASE 0,25 kW - MONOFASE - SINGLE-PHASE 0,37 kW								
TP 15 030A	30 mm	58	35,0 lt/h	20 bar	10 bar	3/8 g.f.	11,2 kg	9,8 kg
TP 15 030C	30 mm	116	70,0 lt/h	20 bar	10 bar	3/8 g.f.	11,2 kg	9,8 kg
TP 15 038A	38 mm	58	55,0 lt/h	17 bar	10 bar	3/8 g.f.	12,8 kg	10 kg
TP 15 038C	38 mm	116	110,0 lt/h	17 bar	10 bar	3/8 g.f.	12,8 kg	10 kg
TP 15 048A	48 mm	58	85,0 lt/h	10 bar	10 bar	1/2 g.f.	12,8 kg	10 kg
TP 15 048C	48 mm	116	170,0 lt/h	10 bar	10 bar	1/2 g.f.	12,8 kg	10 kg
TP 15 054A	54 mm	58	110,0 lt/h	8 bar	8 bar	1/2 g.f.	14,6 kg	10,3 kg
TP 15 054C	54 mm	116	220,0 lt/h	8 bar	8 bar	1/2 g.f.	14,6 kg	10,3 kg
TP 15 064A	64 mm	58	152,0 lt/h	6 bar	4 bar	3/4 g.f.	15,7 kg	10,5 kg
TP 15 064C	64 mm	116	304,0 lt/h	6 bar	4 bar	3/4 g.f.	15,7 kg	10,5 kg

**SPECIALI CORPI POMPA IN PVC PER ALTE PRESSIONI - SPECIAL PVC PUMP HEADS FOR HIGH PRESSURES**

PRESSIONE - PRESSURE
20 bar

Ø PISTONI - Ø PISTONS
11-17-25-30-38 mm

*Dati dimensionali - Dimensions*

Ø PISTONI Ø PISTONS	SS316				PVC			
	A	B	C	T	A	B	C	T
6 mm	120	210	1/4 g.f.	68	157	216	1/4 g.f.	80
11 mm	120	210	1/4 g.f.	68	157	216	1/4 g.f.	80
17 mm	120	210	3/8 g.f.	68	147	216	3/8 g.f.	80
25 mm	120	215	3/8 g.f.	68	147	225	3/8 g.f.	80
30 mm	120	215	3/8 g.f.	68	147	225	3/8 g.f.	80
38 mm	160	227	3/8 g.f.	88	168	235	3/8 g.f.	100
48 mm	160	227	1/2 g.f.	88	196	240	1/2 g.f.	100
54 mm	173	229	1/2 g.f.	108	216	240	1/2 g.f.	120
64 mm	202	238	3/4 g.f.	108	222	250	3/4 g.f.	120



# TAURUS SERIES

POMPE DOSATRICI ELECTROMECCANICHE - ELECTROMECHANIC DOSING PUMPS



## TP VERSIONE CON PISTONE - PISTON VERSION

### CORSA 25 mm.

- Portata massima 40÷1000 lt/h
- Pressione massima 20 bar
- Frequenza fissa 58-116 colpi/min
- Diametro pistone 25÷89 mm
- Motori 0,25/0,37/0,55/0,75 kW di tipo unificato IP55

### STROKE 25 mm.

- 40÷1000 lt/h max flow rate
- 20 bar max pressure
- 58-116 strokes/min. fixed frequency
- 25÷89 mm piston diameter
- 0,25/0,37/0,55/0,75 kW standard IP55 motors



# TAURUS SERIES

POMPE DOSATRICI ELECTROMECCANICHE - ELECTROMECHANIC DOSING PUMPS

TP 25 VERSIONE CON PISTONE - PISTON VERSION								
MODELLI MODELS	Ø PISTONI Ø PISTONS	COLPI/min. STROKES/min.	PORTATE FLOW RATES	PRESSIONI - PRESSURES SS316	PVC	CONNESSIONI CONNECTIONS	PESI - WEIGHTS SS316	PVC
TRIFASE - THREE-PHASE 0,25 kW - MONOFASE - SINGLE-PHASE 0,37 kW								
TP 25 0025A	25 mm	58	40,0 lt/h	20 bar	10 bar	3/8" g.f.	15,5 kg	14,1 kg
TP 25 0025C	25 mm	116	80,0 lt/h	20 bar	10 bar	3/8" g.f.	15,5 kg	14,1 kg
TP 25 0030A	30 mm	58	55,0 lt/h	20 bar	10 bar	3/8" g.f.	15,5 kg	14,1 kg
TP 25 0030C	30 mm	116	112,0 lt/h	20 bar	10 bar	3/8" g.f.	15,5 kg	14,1 kg
TRIFASE - THREE-PHASE 0,37 kW - MONOFASE - SINGLE-PHASE 0,55 kW								
TP 25 038A	38 mm	58	90,0 lt/h	20 bar	10 bar	1/2" g.f.	18,4 kg	15,6 kg
TP 25 038C	38 mm	116	180,0 lt/h	20 bar	10 bar	1/2" g.f.	18,4 kg	15,6 kg
TRIFASE - THREE-PHASE 0,55 kW - MONOFASE - SINGLE-PHASE 0,75 kW								
TP 25 048A	48 mm	58	140,0 lt/h	20 bar	10 bar	1/2" g.f.	18,4 kg	15,6 kg
TP 25 048C	48 mm	116	284,0 lt/h	20 bar	10 bar	1/2" g.f.	18,4 kg	15,6 kg
TP 25 054A	54 mm	58	180,0 lt/h	15 bar	10 bar	1/2" g.f.	20,2 kg	15,6 kg
TP 25 054C	54 mm	116	365,0 lt/h	15 bar	10 bar	1/2" g.f.	20,2 kg	15,6 kg
TRIFASE - THREE-PHASE 0,75 kW - MONOFASE - SINGLE-PHASE 1,1 kW								
TP 25 064A	64 mm	58	250,0 lt/h	10 bar	10 bar	3/4" g.f.	21,3 kg	16,1 kg
TP 25 064C	64 mm	116	505,0 lt/h	10 bar	10 bar	3/4" g.f.	21,3 kg	16,1 kg
TP 25 076A	76 mm	58	365,0 lt/h	7 bar	7 bar	1" g.f.	28,2 kg	18,2 kg
TP 25 076C	76 mm	116	730,0 lt/h	7 bar	7 bar	1" g.f.	28,2 kg	18,2 kg
TP 25 089A	89 mm	58	495,0 lt/h	5 bar	5 bar	1" g.f.	30,4 kg	18,6 kg
TP 25 089C	89 mm	116	1000,0 lt/h	5 bar	5 bar	1" g.f.	30,4 kg	18,6 kg

## SPECIALI CORPI POMPA IN PVC PER ALTE PRESSIONI - SPECIAL PVC PUMP HEADS FOR HIGH PRESSURES

PRESSIONE - PRESSURE
20 bar
Ø PISTONI - Ø PISTONS
38 - 48 mm

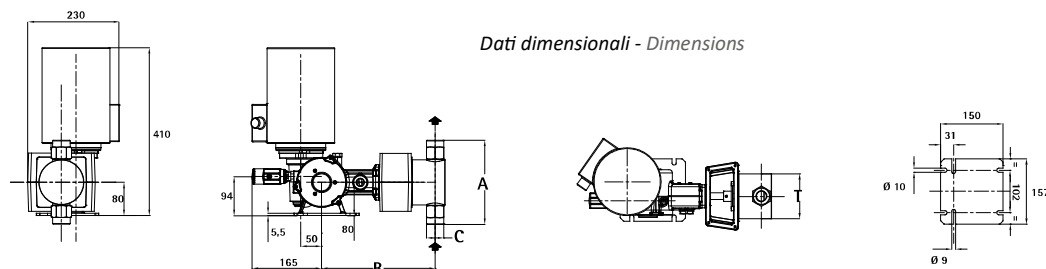

Dati dimensionali - Dimensions

Ø PISTONI Ø PISTONS	SS316				PVC				
	A	B	C	T	A	B	C	T	
25 mm	120	258	3/8" g.f.	68	157	258	3/8" g.f.	80	
30 mm	120	258	3/8" g.f.	68	157	258	3/8" g.f.	80	
38 mm	160	268	1/2" g.f.	88	168	268	3/8" g.f.	100	
48 mm	160	268	1/2" g.f.	88	196	268	1/2" g.f.	100	
54 mm	173	268	1/2" g.f.	108	216	268	1/2" g.f.	120	
64 mm	202	273	3/4" g.f.	108	222	273	3/4" g.f.	120	
76 mm	238	288	1" g.f.	138	244	288	1" g.f.	148	
89 mm	252	288	1" g.f.	150	256	288	1" g.f.	160	



# TAURUS SERIES

POMPE DOSATRICI ELECTROMECCANICHE - ELECTROMECHANIC DOSING PUMPS



## TM 2-4-6 VERSIONE CON DIAFRAMMA - DIAPHRAGM VERSION

### CORSA 2-4-6 mm.

- Portata massima 5,5÷460 lt/h
- Pressione massima 100 bar
- Frequenza fissa 58-116 colpi/min
- Diametro membrana 65÷165 mm
- Motori 0,18/0,25/0,37 kW di tipo unificato IP55

### STROKE 2-4-6 mm.

- 5,5÷460 lt/h max flow rate
- 100 bar max pressure
- 58-116 strokes/min. fixed frequency
- 65÷165 mm diaphragm diameter
- 0,18/0,25/0,37 kW standard IP55 motors



# TAURUS SERIES

POMPE DOSATRICI ELECTROMECCANICHE - ELECTROMECHANIC DOSING PUMPS

TM 2 - 4 - 6 VERSIONE CON DIAFRAMMA - DIAPHRAGM VERSION								
MODELLI MODELS	Ø MEMBRANA Ø DIAPHRAGM	L.CORSA STROKE LENGTH	COLPI/min. STROKES/min.	PORTATE FLOW RATES	PRESSIONI PRESSURES	CONNESSIONI CONNECTIONS	PESI - WEIGHTS SS316	PVC/PP/PVDF
TRIFASE - THREE-PHASE 0,18 kW - MONOFASE - SINGLE-PHASE 0,25 kW								
TM 02 064A	64 mm	2 mm	58	5,5 lt/h	10 bar	1/4" g.f.	10,2 kg	8,5 kg
TM 02 064B	64 mm	2 mm	78	8,0 lt/h	10 bar	1/4" g.f.	10,2 kg	8,5 kg
TM 02 064C	64 mm	2 mm	116	11,0 lt/h	10 bar	1/4" g.f.	10,2 kg	8,5 kg
TRIFASE - THREE-PHASE 0,118 kW - MONOFASE - SINGLE-PHASE 0,25 kW								
TM 02 094A	94 mm	2 mm	58	20,0 lt/h	10 bar	3/8" g.f.	10,7 kg	8,4 kg
TM 02 094B	94 mm	2 mm	78	26,0 lt/h	10 bar	3/8" g.f.	10,7 kg	8,4 kg
TM 02 094C	94 mm	2 mm	116	40,0 lt/h	10 bar	3/8" g.f.	10,7 kg	8,4 kg
TRIFASE - THREE-PHASE 0,37 kW - MONOFASE - SINGLE-PHASE 0,55 kW								
TM 04 108A	108 mm	4 mm	58	60,0 lt/h	10 bar	3/8" g.f.	13,3 kg	10,1 kg
TM 04 108B	108 mm	4 mm	78	80,0 lt/h	10 bar	3/8" g.f.	13,3 kg	10,1 kg
TM 04 108C	108 mm	4 mm	116	120,0 lt/h	10 bar	3/8" g.f.	13,3 kg	10,1 kg
TM 06 138A	138 mm	6 mm	58	155,0 lt/h	7 bar	3/4" g.f.	18,4 kg	12,3 kg
TM 06 138B	138 mm	6 mm	78	220,0 lt/h	7 bar	3/4" g.f.	18,4 kg	12,3 kg
TM 06 138C	138 mm	6 mm	116	310,0 lt/h	7 bar	1" g.f.	18,4 kg	12,3 kg
TM 06 165A	165 mm	6 mm	58	230,0 lt/h	5 bar	1" g.f.	22,0 kg	13,2 kg
TM 06 165B	165 mm	6 mm	78	330,0 lt/h	5 bar	1" g.f.	22,0 kg	13,2 kg
TM 06 165C	165 mm	6 mm	116	500,0 lt/h	3 bar	1" g.f.	22,0 kg	13,2 kg

**SPECIALI CORPI POMPA IN PVC PER ALTE PRESSIONI - SPECIAL PVC PUMP HEADS FOR HIGH PRESSURES**

PRESSIONE - PRESSURE
16 bar

Ø PISTONI - Ø PISTONS
64 - 94 mm

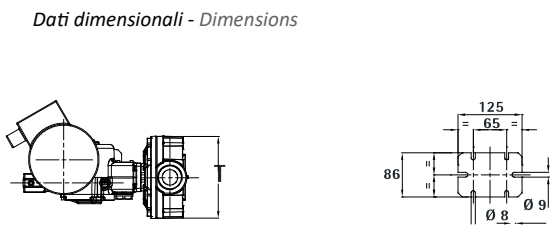
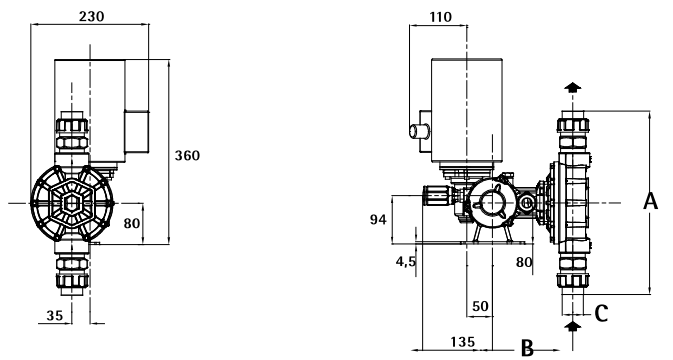

Ø MEMBRANA Ø DIAPHRAGM	SS316				PVC/PP/PVDF			
	A	B	C	T	A	B	C	T
65 mm	208	149	1/4" g.f.	98	150	144	1/4" g.f.	98
94 mm	236	144	3/8" g.f.	117	172	146	3/8" g.f.	120
108 mm	248	144	3/8" g.f.	131	212	146	3/8" g.f.	140
138 mm	347	158	3/4" g.f. - 1" g.f.	160	258	157	3/8" g.f. - 1" g.f.	170
165 mm	377	160	1" g.f.	193	296	157	1" g.f.	190





# TAURUS SERIES

POMPE DOSATRICI ELECTROMECCANICHE - ELECTROMECHANIC DOSING PUMPS



## TM 07 VERSIONE CON DIAFRAMMA DIRETTO - DIRECT DIAPHRAGM VERSION

- MECCANISMO di RITORNO A MOLLA e CASSA IN PP
- Portate massima 10÷120 lt/h
- Pressione massima 5 bar
- Velocità pistone 26-43-86-130-144 colpi/min
- Diametri Membrana 70 mm
- Motori 0,6 kW di tipo unificato IP55 50/60 Hz
- SPRING RETURN MECHANISM and PP CASE
- 10÷120 lt/h max flow rates
- 5 bar max pressure
- 26-43-86-130-144 Strokes/min
- 70 mm Diaphragm diameter
- 0,6 kW - 50/60 Hz standard motors - IP55



# TAURUS SERIES

POMPE DOSATRICI ELECTROMECCANICHE - ELECTROMECHANIC DOSING PUMPS

TM 07 VERSIONE CON DIAFRAMMA - DIAPHRAGM VERSION								
MODELLI MODELS	Ø MEMBRANA Ø DIAPHRAGM	L.CORSA STROKE LENGTH	COLPI/min. STROKES/min.	PORTATE FLOW RATES	PRESSIONI PRESSURES	CONNESSIONI CONNECTIONS	PESI - WEIGHTS SS316	PVC/PP/PVDF
TRIFASE - THREE-PHASE 0,06 kW - MONOFASE - SINGLE-PHASE 0,06 kW								
TM 07 A	70 mm	4,2 mm	86	40 lt/h	5 bar	8x12 - 1/2 g.f. (aisi)	4 kg	3 kg only PVDF
TM 07 B	70 mm	5 mm	130	60 lt/h	5 bar	8x12 - 1/2 g.f. (aisi)	4 kg	3 kg only PVDF
TM 07 C	70 mm	6,8 mm	144	90 lt/h	5 bar	8x12 - 1/2 g.f. (aisi)	4 kg	3 kg only PVDF
TM 07 D	70 mm	6,8 mm	144	120 lt/h	3 bar	8x12 - 1/2 g.f. (aisi)	4 kg	3 kg only PVDF

DISPONIBILE LA VERSIONE MONOFASE A MAX 1 BAR - SINGLEPHASE VERSION AT MAX 1 BAR IS ALSO AVAILABLE

A [mm]	B [mm]	C [BSP / mm]		T [mm]	SINGLE / THREE PHASES MOTOR		
		AISI 316	1/2" g/f		D [mm]	E [mm]	F [mm]
242	93,5	AISI 316	1/2" g/f	372	372	256	125
		PVDF	8x12 (std)				

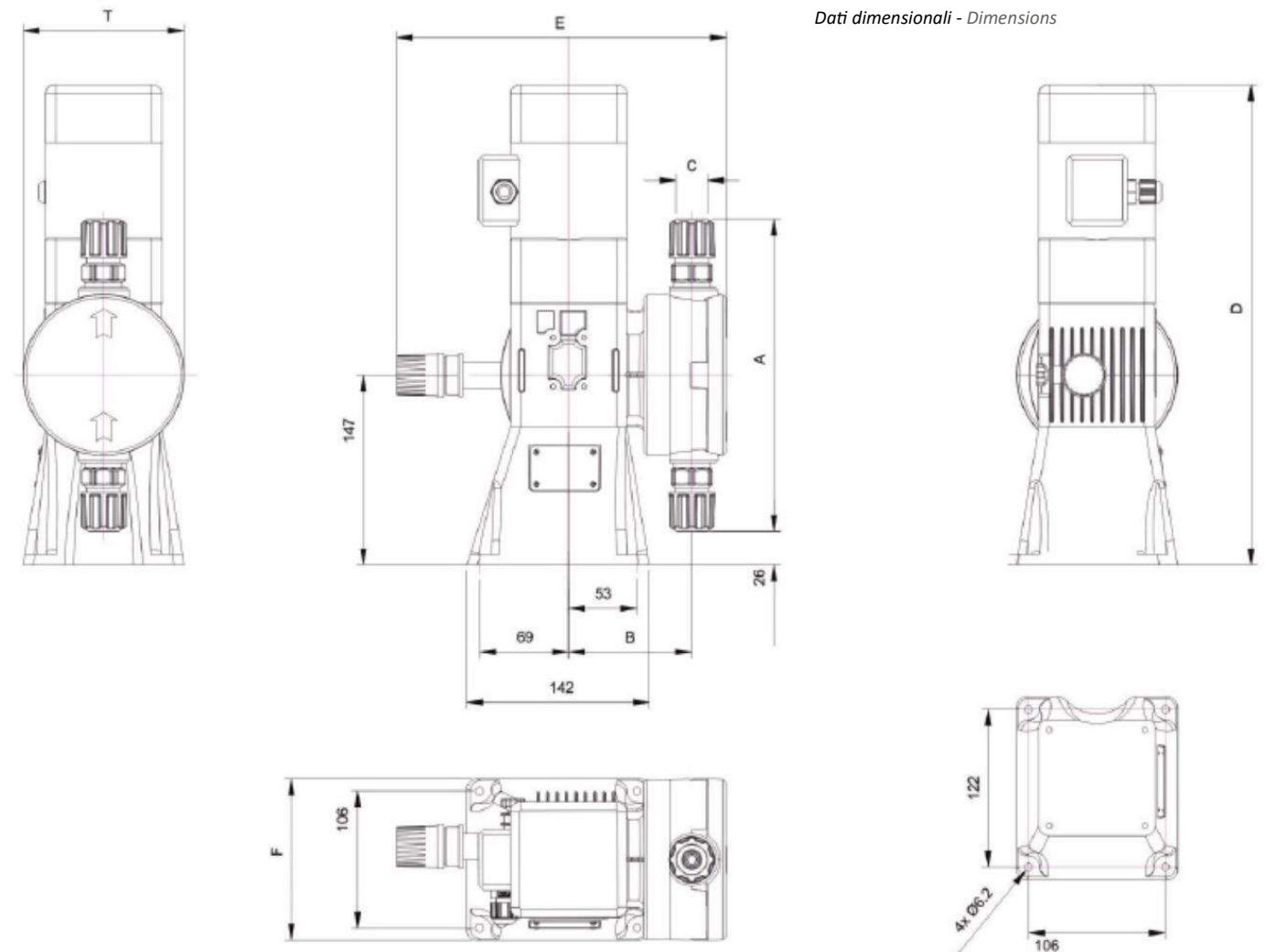



# TAURUS SERIES

POMPE DOSATRICI ELECTROMECCANICHE - ELECTROMECHANIC DOSING PUMPS

## ESEMPI DI INSTALLAZIONE - INSTALLATION EXAMPLES

Pompa con Inverter collegata ad un misuratore elettromagnetico di portata (4-20 mA) - Pompa con Inverter collegata ad uno strumento di misura (4-20 mA)

Pump equipped with Inverter and connected to an electromagnetic flow rate meter (4-20 mA) - Pump equipped with Inverter and connected to a measuring instrument (4-20 mA)

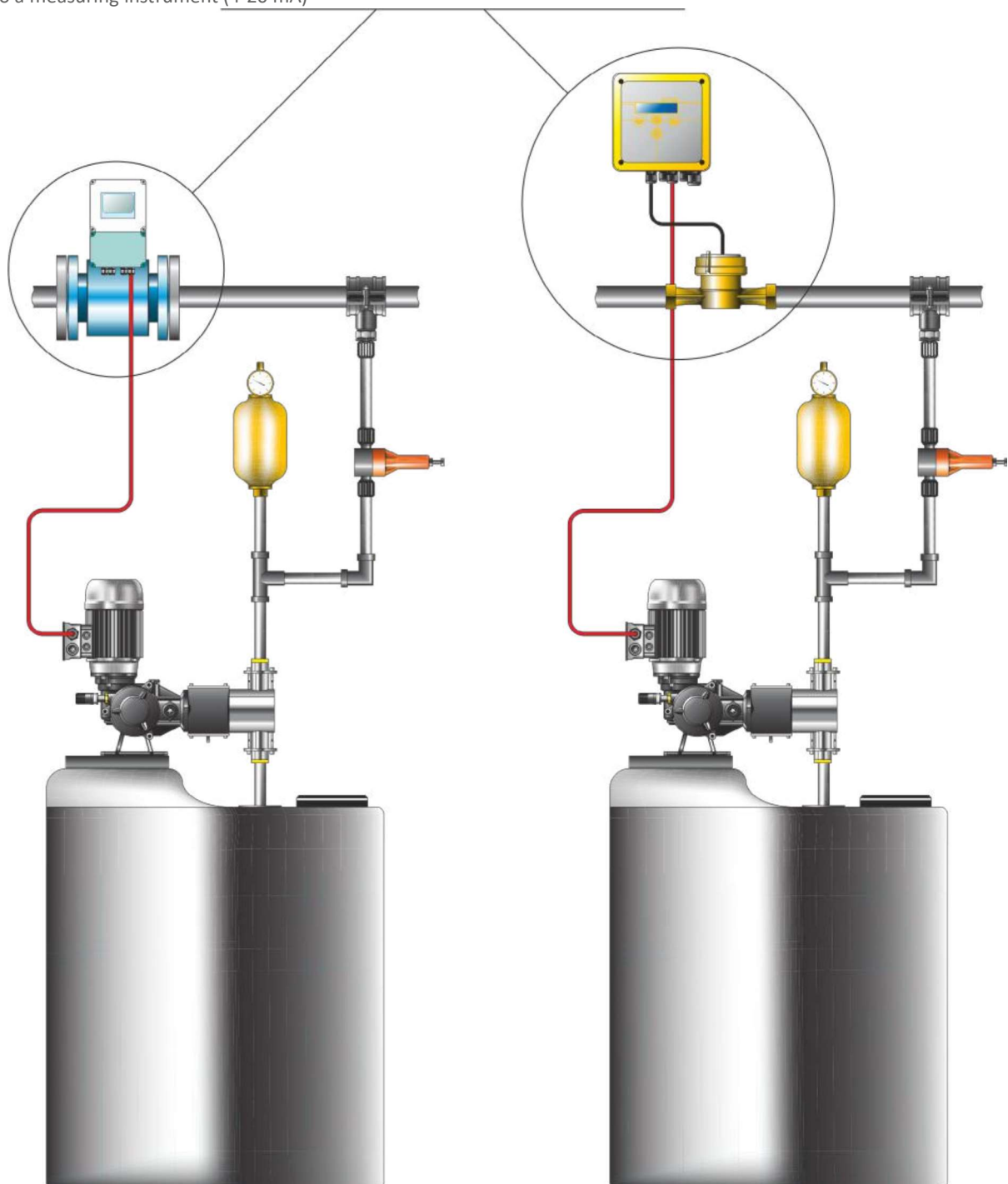

# TAURUS SERIES

POMPE DOSATRICI ELECTROMECCANICHE - ELECTROMECHANIC DOSING PUMPS



## TM/TP 12 VDC

- **POMPE DOSATRICI PISTONE/MEMBRANA 12VDC**
- Al fine di soddisfare le esigenze di alimentazione delle nostre pompe in quelle condizioni dove non è possibile utilizzare la normale rete elettrica facendo ricorso all'utilizzo di batterie o pannelli solari, completiamo la gamma con una serie di modelli equipaggiati da motore alimentato a 12 VDC
- **12VDC PISTON/DIAPHRAGM DOSING PUMPS**
- In order to meet the power requirement of our pumps, when it is not possible to use the normal power and only batteries or solar panels can solve the problem, our pump range is integrated by a series of models equipped with a 12VDC motor

### TP 15 12VDC VERSIONE CON PISTONE - PISTON VERSION

MODELLI MODELS	Ø PISTONI Ø PISTONS	COLPI/min. - STROKES/min.		PORTATE - FLOW RATES		PRESSIONI - PRESSURES		CONNESSIONI - CONNECTIONS	
		SS316	PVC	SS316	PVC	SS316	PVC	SS316	PVC
12 VDC (KW) 0,40 kW (IP55)									
TP 15 025A	25 mm	84	85	34 lt/h	36 lt/h	20 bar	10 bar	3/8" g.f.	3/8" g.f.
TP 15 025C	25 mm	140	145	60 lt/h	62 lt/h	20 bar	10 bar	3/8" g.f.	3/8" g.f.
TP 15 030A	30 mm	72	72	40 lt/h	40 lt/h	20 bar	10 bar	3/8" g.f.	3/8" g.f.
TP 15 030C	30 mm	140	140	78 lt/h	78 lt/h	20 bar	10 bar	3/8" g.f.	3/8" g.f.
TP 15 038A	38 mm	68	68	60 lt/h	60 lt/h	17 bar	10 bar	3/8" g.f.	3/8" g.f.
TP 15 038C	38 mm	128	130	114 lt/h	118 lt/h	17 bar	10 bar	3/8" g.f.	3/8" g.f.
TP 15 048A	48 mm	72	72	100 lt/h	100 lt/h	10 bar	10 bar	1/2" g.f.	1/2" g.f.
TP 15 048C	48 mm	140	140	190 lt/h	190 lt/h	10 bar	10 bar	1/2" g.f.	1/2" g.f.
TP 15 054A	54 mm	72	72	140 lt/h	140 lt/h	8 bar	8 bar	1/2" g.f.	1/2" g.f.
TP 15 054C	54 mm	140	140	270 lt/h	270 lt/h	8 bar	8 bar	1/2" g.f.	1/2" g.f.
TP 15 064A	64 mm	76	74	180 lt/h	185 lt/h	6 bar	4 bar	3/4" g.f.	3/4" g.f.
TP 15 064C	64 mm	140	142	350 lt/h	360 lt/h	6 bar	4 bar	3/4" g.f.	3/4" g.f.

### TP 2 - 4 - 6 12VDC VERSIONE CON DIAFRAMMA - DIAPHRAGM VERSION

MODELLI MODELS	Ø MEMBRANA Ø DIAPHRAGM	COLPI/min. - STROKES/min.		PORTATE - FLOW RATES		PRESSIONI - PRESSURES		CONNESSIONI - CONNECTIONS	
		SS316	PP/PVC	SS316	PP/PVC	SS316	PP/PVC	SS316	PP/PVC
12 VDC (KW) 0,40 kW (IP55)									
TM 02 094A	94 mm	72	72	23 lt/h	24 lt/h	16 bar	10 bar	3/8" g.f.	3/8" g.f.
TM 02 094B	94 mm	90	90	30 lt/h	31 lt/h	16 bar	10 bar	3/8" g.f.	3/8" g.f.
TM 02 094C	94 mm	144	145	45 lt/h	46 lt/h	16 bar	10 bar	3/8" g.f.	3/8" g.f.
TM 04 108A	108 mm	72	72	65 lt/h	65 lt/h	10 bar	10 bar	3/8" g.f.	3/8" g.f.
TM 04 108B	108 mm	92	92	90 lt/h	90 lt/h	10 bar	10 bar	3/8" g.f.	3/8" g.f.
TM 06 108C	108 mm	140	140	120 lt/h	120 lt/h	10 bar	10 bar	3/8" g.f.	3/8" g.f.
TM 06 138A	138 mm	72	72	200 lt/h	200 lt/h	7 bar	7 bar	3/8" g.f.	3/8" g.f.
TM 06 138B	138 mm	92	92	250 lt/h	250 lt/h	7 bar	7 bar	3/8" g.f.	3/8" g.f.
TM 06 138C	138 mm	140	140	390 lt/h	390 lt/h	7 bar	7 bar	1" g.f.	1" g.f.
TM 06 165A	165 mm	70	70	300 lt/h	300 lt/h	5 bar	5 bar	1/2" g.f.	1/2" g.f.
TM 06 165B	165 mm	95	95	380 lt/h	380 lt/h	5 bar	5 bar	1/2" g.f.	1/2" g.f.
TM 06 165C	165 mm	135	136	620 lt/h	620 lt/h	3 bar	3 bar	1/2" g.f.	1/2" g.f.

# TAURUS SERIES

## POMPA A DIAFRAMMA MECCANICA - MECHANICAL DIAPHRAGM PUMP



### Caratteristiche Tecniche Technical Characteristics

- Portata fino a 530 l/h
- Pressione fino a 12 bar
- Membrana in PTFE ad azionamento meccanico
- Regolazione della portata da 0 a 100%
- Frequenza colpi: 58/78/116/156 colpi / minuto
- Lunghezza della corsa: 2/4 / 6,4 / 7,4 mm
- Diametro del diaframma: 65/96/124/140 mm
- Motore: 0,25 / 0,37 kW
- Temperatura massima del liquido pompato: 40 °C
- Temperatura ambiente massima: 55 °C
- Regolazione della corsa con sistema di bloccaggio
- Classe di protezione della custodia: IP55
- Materiale della testa della pompa: - SS 316L o - PVDF

- Flow Rate up to 530 l/h
- Pressure up to 12 bar
- Mechanically operated PTFE diaphragm
- Flow rate adjustment from 0 to 100%
- Stroke Rate: 58 / 78 / 116 / 156 strokes/minute
- Stroke Length: 2 / 4 / 6.4 / 7.4 mm
- Diaphragm Diameter: 65 / 96 / 124 / 140 mm
- Motor: 0.25 / 0.37 kW
- Maximum temperature of pumped liquid: 40 °C
- Maximum ambient temperature: 55 °C
- Stroke adjustment with locking system
- Protection Class: IP55
- Pump head material: SS 316L or PVDF

### TMP1

- Le pompe dosatrici TMP1 offrono un elevato livello di affidabilità con un valore eccezionale per applicazioni fino a 12 Bar e portate fino a 530 l/h
  - Una gamma di pompe dosatrici compatte, leggere, robuste e semplici progettate per basse pressioni di scarico, durabilità ed economicità, utilizzate principalmente nel trattamento delle acque e nell'industria alimentare in applicazioni pulite. Progettato per fornire costi operativi globali ridotti nel tempo, il diaframma in PTFE ad azionamento meccanico aumenta la durata del diaframma eliminando le sollecitazioni inerenti alla maggior parte dei progetti di pompe.
  - I modelli TMP1 sono pompe multiuso e possono gestire tutti i reagenti noti. Sono raccomandati per un servizio continuo e possono funzionare a secco senza danni alla pompa.
  - Le pompe TMP1 incorporano un sistema eccentrico variabile che riduce al minimo pulsazioni e shock.
  - Le pompe dosatrici TMP1 sono costituite da un involucro metallico resistente, progettato per resistere ad ambienti difficili e adatto a un gran numero di usi industriali diversi dal trattamento dell'acqua, come l'iniezione di reagenti a media pressione.
  - Le pompe TMP1 hanno una regolazione della portata durante il funzionamento o l'arresto da 0 a 100%, con una temperatura massima di liquido pompato fino a 40 °C volta a fornire prestazioni eccezionali in un'ampia gamma di ambienti di portata e pressione.
- TMP1 dosing pumps are highly reliable and effective when used at a max. pressure of 12 Bar and a max. flow rate of 530 l/h
  - A range of dosing pumps that are compact, lightweight, sturdy and simple designed for low discharge pressures, durability and cost effectiveness, mainly used in water treatment and in the food industry (clean areas). Designed to reduce operating costs over time, the mechanically-operated PTFE diaphragm increases diaphragm life by eliminating the stress typical of most of pump models.
  - TMP1 models are multipurpose pumps and are suitable for all known reagents. They are recommended for continuous work and can run dry without damaging the pump.
  - TMP1 pumps are equipped with a variable eccentric system reducing pulsation and shock.
  - TMP1 dosing pumps consists of durable, metallic housing designed to withstand harsh environments and are suitable for a large number of industrial uses other than water treatment, such as the injection of reagents at medium pressure.
  - While using TMP1 pumps flow rate can be adjusted or stopped from 0 to 100%, with a maximum temperature of pumped liquid up to 40 °C guaranteeing an exceptional performance within a wide range of flow and pressure conditions.

Curva prestazionale P [barg] - Q [l/h]  
Performance curve P [barg] - Q [l/h]

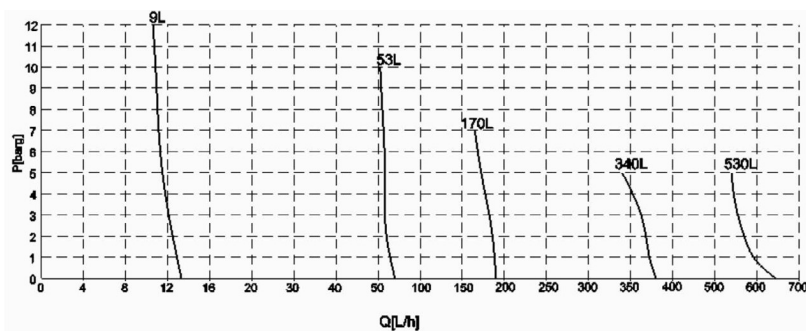



# TAURUS SERIES

POMPA A DIAFRAMMA MECCANICA - MECHANICAL DIAPHRAGM PUMP

TMP1 DATI SULLE PRESTAZIONI - TMP1 PERFORMANCE DATA										
MODELLI MODELS	DIAMETRO DIAMETER	LUN- GHEZZA CORSA STROKE LENGTH	FRE- QUENZA COLPI STROKE RATE	PORTATA FLOW RATE	PRESSIONE MAX MAX PRESSURE	CONNESSIONI CONNECTIONS		MOTORE MOTOR	PESO LORDO GROSS WEIGHT (KG)	DIMENSIONI IMBALLO BOX DIMENSIONS L W H (mm)
						SS316L	PVDF			
TMP1A065C**A40000	65 mm	2	116	9 l/h	12 bar	BSPf 1/4"	8x12 PE hose	0,25/4	16	450x300x550
TMP1C096B**A40000	96 mm	4	78	53 l/h	10 bar	BSPf 3/8"	DN 10	0,25/4	16	450x300x550
TMP1D124B**B40000	124 mm	6,4	78	170 l/h	7 bar	BSPf 3/4"	DN 20	0,37/4	20	450x300x550
TMP1D124B**B20000	124 mm	6,4	156	340 l/h	5 bar	BSPf 3/4"	DN 20	0,37/2	20	450x300x550
TMP1E140B**B20000	140 mm	7,4	156	530 l/h	5 bar	BSPf 1"	DN 25	0,37/2	20	450x300x550

- 1) (\*\*\*) Materiale delle parti bagnate disponibili: SS316L e PVDF;
- 2) Oltre al motore STD può anche essere dotato anche di motore VSD (a velocità variabile) o motore antideflagrante (Exd IIB T4);
- 3) Testato con acqua a 20°C a 50 Hz; Valori della portata con motore a 50 Hz. Moltiplicare per 1,2 con 60 Hz

- 1) (\*\*\*) Material of the available wetted parts: SS316L and PVDF ;
- 2) In addition to the STD motor, it can also be equipped with VSD motor (Variable Speed Drive) or explosion-proof motor (Exd IIB T4);
- 3) Tested with water at 20°C at 50 Hz; Flow rate values with motor at 50Hz. Multiply by 1.2 for 60 Hz.

MATERIALE DEL DOSATORE - LIQUID END MATERIAL				
MATERIALE MATERIAL	CORPO DOSATORE LIQUID END			
	21	41	24	44
TESTA DELLA POMPA PUMP HEAD	SS 316L	PVDF	SS 316L	PVDF
MEMBRANA DIAPHRAGM	PTFE	PTFE	PTFE	PTFE
TENUTA SEAL	FPM	FPM	EPDM	EPDM
SFERA BALL	SS 316L	CERAMICA CERAMIC	SS 316L	CERAMICA CERAMIC
ALLOGGIAMENTO SFERA BALL HOUSING	SS 316L	PTFE	SS 316L	PTFE

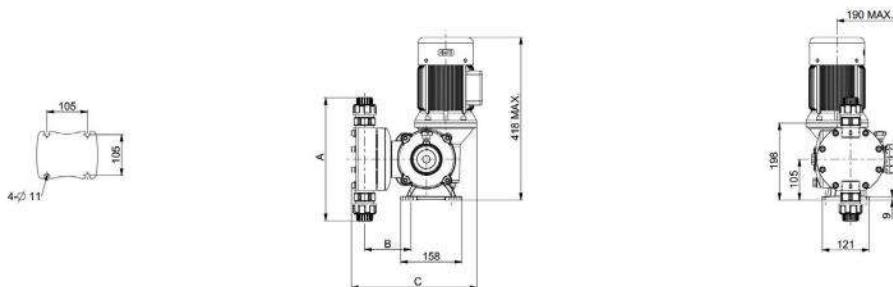

DISEGNI TECNICI TMP1 - TMP1 Installation Drawing																
MATERIALE TESTA DELLA POMPA PUMP HEAD MATERIAL	DIAFRAMMA DIAMETRO 65mm DIAPHRAGM DIAMETER 65mm				DIAFRAMMA DIAMETRO 96mm DIAPHRAGM DIAMETER 96mm				DIAFRAMMA DIAMETRO 96mm DIAPHRAGM DIAMETER 96mm				DIAFRAMMA DIAMETRO 96mm DIAPHRAGM DIAMETER 96mm			
	CONNESSIONE CONNECTION	A	B	C	CONNESSIONE CONNECTION	A	B	C	CONNESSIONE CONNECTION	A	B	C	CONNESSIONE CONNECTION	A	B	C
PVDF	8x12 HOSE	166	104	303	BSPf 3/8"	222	108	301	BSPf 3/4"	293	118	322	BSPf 1"	293	118	322
SS316L	BSPf 1/4"	175	108	294	BSPf 3/8"	167	107	293	BSPf 3/4"	210	113	306	BSPf 1"	210	113	306

# TAURUS SERIES

POMPA A DIAFRAMMA MECCANICA - MECHANICAL DIAPHRAGM PUMP



*Caratteristiche Tecniche*  
*Technical Characteristics*

- Portata fino a 2.300 l/h
- Pressione fino a 10 bar
- Membrana in PTFE ad azionamento meccanico
- Regolazione della portata da 0 a 100%
- Frequenza colpi: 43/86/131/175 colpi / minuto
- Lunghezza della corsa: 7 / 8 / 9 / 15 mm
- Diametro del diaframma: 124/140/157/179 mm
- Motore: 0,55 / 0,75 / 1,1 kW
- Temperatura massima del liquido pompato: 40 °C
- Temperatura ambiente massima: 55 °C
- Regolazione della corsa con sistema di bloccaggio
- Classe di protezione della custodia: IP55
- Materiale della testa della pompa: - SS 316L o - PVDF

- Flow Rate up to 2.300 l/h
- Pressure up to 10 bar
- Mechanically operated PTFE diaphragm
- Flow rate adjustment from 0 to 100%
- Stroke Rate: 43 / 86 / 131 / 175 strokes/minute
- Stroke Length: 7 / 8 / 9 / 15 mm
- Diaphragm Diameter: 124 / 140 / 157 / 179 mm
- Motor: 0.55 / 0.75 / 1.1 kW
- Maximum temperature of pumped liquid: 40 °C
- Maximum ambient temperature: 55 °C
- Stroke adjustment with locking system
- Protection Class: IP55
- Pump head material: - SS 316L or PVDF

## TMP2

- Le pompe dosatrici TMP2 offrono un elevato livello di affidabilità con un valore eccezionale per applicazioni fino a 10 Bar e portate fino a 2.300 l/h
  - Una gamma di pompe dosatrici compatte, leggere, robuste e semplici progettate per basse pressioni di scarico, durabilità ed economicità, utilizzate principalmente nel trattamento delle acque e nell'industria alimentare in applicazioni pulite. Progettato per fornire costi operativi globali ridotti nel tempo, il diaframma in PTFE ad azionamento meccanico aumenta la durata del diaframma eliminando le sollecitazioni inerenti alla maggior parte dei progetti di pompe.
  - I modelli TMP2 sono pompe multiuso e possono gestire tutti i reagenti noti. Sono raccomandati per un servizio continuo e possono funzionare a secco senza danni alla pompa.
  - Le pompe TMP2 incorporano un sistema eccentrico variabile che riduce al minimo pulsazioni e shock.
  - Le pompe dosatrici TMP2 sono costituite da un involucro metallico resistente, progettato per resistere ad ambienti difficili e adatto a un gran numero di usi industriali diversi dal trattamento dell'acqua, come l'iniezione di reagenti a media pressione.
  - Le pompe TMP2 hanno una regolazione della portata durante il funzionamento o l'arresto da 0 a 100%, con una temperatura massima di liquido pompato fino a 40 °C volta a fornire prestazioni eccezionali in un'ampia gamma di ambienti di portata e pressione.
- TMP2 dosing pumps are highly reliable and effective when used at a max. pressure of 10 Bar and a max. flow rate of 2.300 l/h
  - A range of dosing pumps that are compact, lightweight, robust and simple designed for low discharge pressures, durability and cost effectiveness, mainly used in water treatment and in the food industry (clean areas). Designed to reduce operating costs over time, the mechanically-actuated PTFE diaphragm increases diaphragm life by eliminating the stress, typical of most of pump models.
  - TMP2 models are multipurpose pumps and are suitable for all known reagents. They are recommended for continuous work and can run dry without damaging the pump.
  - MP2 pumps are equipped with a variable eccentric system reducing pulsation and shock.
  - TMP2 dosing pumps consists of durable, metallic housing designed to withstand harsh environments and suitable for a large number of industrial uses other than water treatment, such as the injection of reagents at medium pressure.
  - While using TMP2 pumps flow rate can be adjusted or stopped from 0 to 100%, with a maximum temperature of pumped liquid up to 40 °C guaranteeing an exceptional performance within a wide range of flow and pressure conditions.

*Curva prestazionale P [barg] - Q [l/h]*  
*Performance curve P [barg] - Q [l/h]*

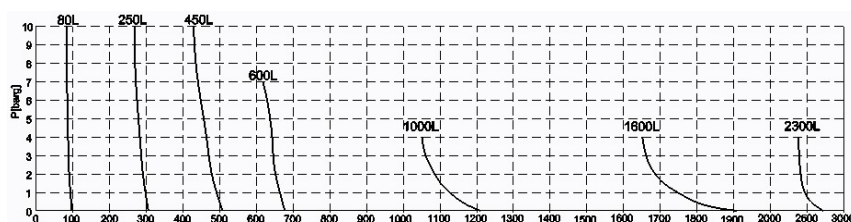



# TAURUS SERIES

## POMPA MECCANICA A DIAFRAMMA - MECHANICAL DIAPHRAGM PUMP

TMP2 DATI SULLE PRESTAZIONI - TMP2 PERFORMANCE DATA										
MODELLI MODELS	DIAMETRO DIAMETER	LUN- GHEZZA CORSA STROKE LENGTH	FRE- QUENZA COLPI STROKE RATE	PORTATA FLOW RATE	PRESSIONE MAX MAX PRESSURE	CONNESSIONI CONNECTIONS		MOTORE MOTOR	PESO LORDO GROSS WEIGHT (KG)	DIMENSIONI IMBALLO CARDBOARD BOX L W H (mm)
						SS316L	PVDF			
TMP2F124D**C40000	124 mm	7	43	80 l/h	10 bar	BSPf 3/4"	BSPf 3/4"	0,55/4	56	700x500x750
TMP2F124F**C40000	124 mm	7	131	250 l/h	10 bar	BSPf 3/4"	BSPf 3/4"	0,55/4	56	700x500x750
TMP2G124G**C40000	124 mm	8	175	450 l/h	10 bar	BSPf 3/4"	BSPf 3/4"	0,55/4	56	700x500x750
TMP2G140G**C40000	140 mm	8	175	600 l/h	7 bar	BSPf 1"	BSPf 1"	0,55/4	60	700x500x750
TMP2H157G**C40000	157 mm	9	175	1000 l/h	4 bar	BSPf 1"	BSPf 1"	0,55/4	60	700x500x750
TMP2I179F**D40000	179 mm	15	131	1600 l/h	4 bar	BSPf 1 1/2"	BSPf 1 1/2"	0,75/4	68	700x500x750
TMP2I179G**E40000	179 mm	15	175	2300 l/h	4 bar	BSPf 1 1/2"	BSPf 1 1/2"	1,1/4	68	700x500x750

- 1) (\*\*) Materiale delle parti bagnate disponibili: SS316L (21/24) e PVDF (41/44);
- 2) Oltre al motore STD può anche essere dotato anche di motore VSD (a velocità variabile) o motore antideflagrante (Exd IIB T4);
- 3) Testato con acqua a 20°C a 50 Hz; Valori della portata con motore a 50 Hz. Moltiplicare per 1,2 con 60 Hz

- 1) (\*\*) Material of the available wetted parts: SS316L (21/24) and PVDF (41/44) ;
- 2) In addition to the STD motor, it can also be equipped with VSD motor (Variable Speed Drive) or explosion-proof motor (Exd IIB T4);
- 3) Tested with water at 20°C at 50 Hz; Flow rate values with motor at 50Hz. Multiply by 1.2 for 60 Hz.

MATERIALE DEL DOSATORE - LIQUID END MATERIAL				
MATERIALE MATERIAL	CORPO DEL DOSATORE LIQUID END			
	21	41	24	44
TESTA DELLA POMPA PUMP HEAD	SS 316L	PVDF	SS 316L	PVDF
MEMBRANA DIAPHRAGM	PTFE	PTFE	PTFE	PTFE
TENUTA SEAL	FPM	FPM	EPDM	EPDM
SFERA BALL	SS 316L	CERAMICA CERAMIC	SS 316L	CERAMICA CERAMIC
ALLOGGIAMENTO SFERA BALL HOUSING	SS 316L	PTFE	SS 316L	PTFE

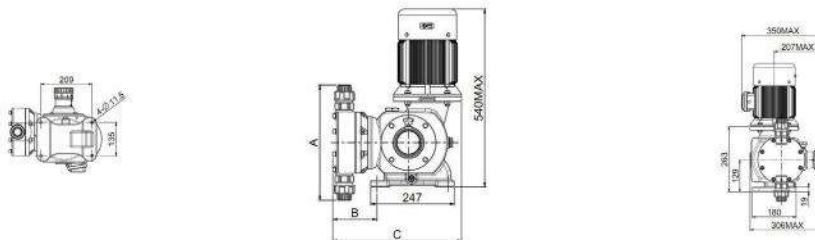

DISEGNI TECNICI TMP2 - TMP2 Installation Drawing																
MATERIALE TESTA DELLA POMPA PUMP HEAD MATERIAL	DIAFRAMMA DIAMETRO 124mm DIAPHRAGM DIAMETER 124mm			DIAFRAMMA DIAMETRO 140mm DIAPHRAGM DIAMETER 140mm			DIAFRAMMA DIAMETRO 157mm DIAPHRAGM DIAMETER 157mm			DIAFRAMMA DIAMETRO 179mm DIAPHRAGM DIAMETER 179mm						
	CONNESSIONE CONNECTION	A	B	C	CONNESSIONE CONNECTION	A	B	C	CONNESSIONE CONNECTION	A	B	C	CONNESSIONE CONNECTION	A	B	C
PVDF	BSPf 3/4"	293	123	372	BSPf 1"	316	129	377	BSPf 1"	334	130	379	BSPf 1 1/2"	424	148	395
SS316L	BSPf 3/4"	216	108	357	BSPf 1"	251	130	378	BSPf 1"	295	132	381	BSPf 1 1/2"	382	160	407





# TAURUS SERIES

POMPE DOSATRICI ELECTROMECCANICHE - ELECTROMECHANIC DOSING PUMPS

## ACCESSORI - ACCESSORIES

- VALVOLE DI SICUREZZA:** utilizzate per evitare anomale sovra pressioni alla pompa e nelle tubazioni. Le pompe dosatrici sono pompe volumetriche che possono raggiungere elevate pressioni in una corsa, esse devono pertanto essere protette da possibili occlusioni delle linee di scarico provocate da sedimentazioni o dall'accidentale chiusura di una valvola di intercettazione. Le pompe a membrana idraulica sono protette da una valvola limitatrice di pressione integrata nel circuito idraulico. Per proteggere l'impianto è necessario installare una valvola di sicurezza sulla linea di mandata.
- PRESSURE SAFETY VALVES** are used to avoid unexpected overpressure that can damage the pump and the tubes. Positive displacement pumps can reach high pressures in one stroke, therefore they should be protected from any possible clogging of the tubes caused, for instance, by accidental closure of the shut-off valve. Hydraulic diaphragm pumps are protected by a pressure relief valve, integrated in the hydraulic circuit. To protect the equipment it is necessary to install a safety valve on the discharge line.

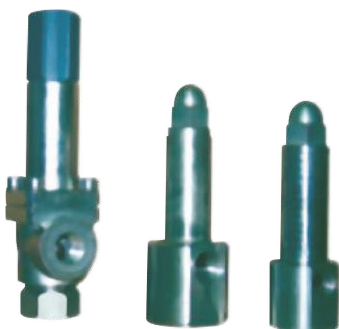

VS Valvole di sicurezza (AISI/PTFE) - Safety valves (SS316/PTFE)				
MODELLI MODELS	PORTATE FLOW RATES	PRESSIONI - PRESSURES		CONNESSIONI CONNECTIONS
		min	max	
VS.1 S	250 lt/h	0 bar	19 bar	1/2" g.f.
	250 lt/h	20 bar	45 bar	1/2" g.f.
	250 lt/h	46 bar	150 bar	1/2" g.f.
VS.2 S	650 lt/h	0 bar	13 bar	3/4" g.f.
	650 lt/h	14 bar	30 bar	3/4" g.f.
	650 lt/h	31 bar	100 bar	3/4" g.f.



VS R Valvole di sicurezza regolabili (AISI/PTFE) - Adjustable safety valves (SS316/PTFE)				
MODELLI MODELS	PORTATE FLOW RATES	PRESSIONI - PRESSURES		CONNESSIONI CONNECTIONS
		min	max	
VS.R S (AISI/PVC)	300 lt/h	0 bar	5 bar	3/8" g.f.
	800 lt/h	0 bar	5 bar	3/4" g.f.
	1500 lt/h	0 bar	5 bar	1" g.f.

- VALVOLE DI CONTROPRESSIONE:** per il corretto funzionamento di una pompa dosatrice e per evitare il passaggio spontaneo di liquido (sifonamento) è necessario che la pressione di aspirazione sia minore della pressione di scarico; qualora questa condizione non fosse rispettata nell'impianto, installare una valvola di contropressione.
- BACK PRESSURE VALVES:** for a correct operation of a dosing pump and to prevent the flow-through of the liquid (siphoning), the discharge pressure should be higher than the suction pressure; if this condition is not respected, then it is advisable to install a back pressure valve.



VZX.S Valvole di contropressione (AISI/PTFE) - Back-pressure valves (SS316/PTFE)			
MODELLI MODELS	PORTATE FLOW RATES	PRESSIONI PRESSURES	CONNESSIONI CONNECTIONS
VZX.S 02	50 lt/h	2 bar	1/4" g.f.
	100 lt/h	2 bar	1/4" g.f.
	200 lt/h	2 bar	3/4" g.f.
	420 lt/h	2 bar	1/2" g.f.
	800 lt/h	2 bar	3/4" g.f.
	1650 lt/h	2 bar	1" g.f.



# TAURUS SERIES

POMPE DOSATRICI ELECTROMECCANICHE - ELECTROMECHANIC DOSING PUMPS

## ACCESSORI - ACCESSORIES

- POLMONI SMORZATORI:** il moto alternativo del pistone delle pompe dosatrici genera pulsazioni: ad ogni corsa, la colonna di liquido delle linee di aspirazione e di mandata è accelerata da zero alla massima velocità poi decelerata fino allo zero. I polmoni smorzatori sono gli accessori consigliati per ridurre elevate e non ammissibili fluttuazioni di pressione o per rendere più lineare il flusso. Analogo risultato può essere ottenuto con l'impiego di un gruppo di dosaggio a teste multiple con costi superiori.
- PULSATION DAMPENERS:** the movement of the piston generates pulsations: at each stroke the liquid contained in the suction and discharge lines is accelerated from zero to the maximum speed and then decelerated to zero again. It is advisable to use these accessories to reduce high and dangerous pressure fluctuations or to obtain a smoother flow. A similar result can be obtained by using multiple heads dosing units, at a higher cost.



VS M Valvole di contropressione regolabili (AISI/PTFE) - Adjustable back pressure valves (SS316/PTFE)				
MODELLI MODELS	PORTATE FLOW RATES	PRESSIONI - PRESSURES min max		CONNESSIONI CONNECTIONS
VS.MS (AISI/PVC)	300 lt/h	0 bar	5 bar	3/8" g.f.
	800 lt/h	0 bar	5 bar	3/4" g.f.
	1500 lt/h	0 bar	5 bar	1" g.f.



PS PVC Polmoni smorzatori - Pulsation dampeners				
CAPACITÀ CAPACITY	PRESSIONI PRESSURES	MATERIALI - MATERIALS Body Diaphragm		CONNESSIONI CONNECTIONS
0,04 lt	10 bar	PVC	FPM	3/8" g.f.
0,1 lt	10 bar	PVC	FPM	3/8" g.f.
0,35 lt	10 bar	PVC	FPM	1/2" g.f.
0,8 lt	10 bar	PVC	FPM	1/2" g.f.
1,5 lt	10 bar	PVC	FPM	3/4" g.f.
2,3 lt	10 bar	PVC	FPM	3/4" g.f.



PS AI Polmoni smorzatori - Pulsation dampeners				
CAPACITÀ CAPACITY	PRESSIONI PRESSURES	MATERIALI - MATERIALS Body Diaphragm		CONNESSIONI CONNECTIONS
0,01 lt	230 bar	AISI	NBR	3/8" g.f.
0,35 lt	230 bar	AISI	NBR	1/2" g.f.
0,5 lt	230 bar	AISI	NBR	1/2" g.f.
0,8 lt	230 bar	AISI	NBR	1/2" g.f.
1,5 lt	230 bar	AISI	NBR	3/4" g.f.
2,3 lt	230 bar	AISI	NBR	3/4" g.f.



PS AI 02 Polmoni smorzatori - Pulsation dampeners				
CAPACITÀ CAPACITY	PRESSIONI PRESSURES	MATERIALI - MATERIALS Body Diaphragm		CONNESSIONI CONNECTIONS
0,5 lt	150 bar	AISI	NBR	3/8" g.f.
0,7 lt	150 bar	AISI	NBR	1/2" g.f.
1 lt	150 bar	AISI	NBR	3/4" g.f.

# TAURUS SERIES

POMPE DOSATRICI ELECTROMECCANICHE - ELECTROMECHANIC DOSING PUMPS

## ACCESSORI - ACCESSORIES



AC FP Valvole di fondo - Foot valves			
CONNESSIONI CONNECTIONS	PORTATE FLOW RATES	MATERIALE MATERIALS	TENUTE SEALS
8/12" g.f.	0 ÷ 60,0 lt/h	PVDF-C*	EPDM
8/12" g.f.	0 ÷ 60,0 lt/h	PVDF	EPDM



AC VI Valvole di iniezione - Injection valves			
CONNESSIONI CONNECTIONS	PORTATE FLOW RATES	MATERIALE MATERIALS	TENUTE SEALS
8/12" g.f.	0 ÷ 60,0 lt/h	PVDF-C*	EPDM
8/12" g.f.	0 ÷ 60,0 lt/h	PVDF	EPDM



AC FP Valvole di fondo - Foot valves			
CONNESSIONI CONNECTIONS	PORTATE - FLOW RATES		MATERIALE MATERIAL
	min	max	
3/8" g.f.	0 ÷ 180,0 lt/h	0 ÷ 112,0 lt/h	AISI/PVC
1/2" g.f.	140,0 ÷ 365,0 lt/h	90,0 ÷ 365,0 lt/h	
3/4" g.f.	250,0 ÷ 505,0 lt/h	-	
1" g.f.	365 ÷ 1000,0 lt/h	250,0 ÷ 505,0 lt/h	



AC VI Valvole di iniezione - Injection valves			
CONNESSIONI CONNECTIONS	PORTATE - FLOW RATES		MATERIALE MATERIAL
	min	max	
3/8" g.f.	0 ÷ 180,0 lt/h	0 ÷ 112,0 lt/h	AISI/PVC
1/2" g.f.	140,0 ÷ 365,0 lt/h	90,0 ÷ 365,0 lt/h	
3/4" g.f.	250,0 ÷ 505,0 lt/h	-	
1" g.f.	365 ÷ 1000,0 lt/h	250,0 ÷ 505,0 lt/h	



AC VIE Valvola iniezione estraibile / Valvola iniezione estraibile con valvola a sfera AC VIE Extractable injection valve / Extractable injection valve with ball valve		
CONNESSIONI CONNECTIONS	CORPO BODY	TENUTE SEALS
1/2" g.m. in/out	PVC	FPM
		EPDM



### FY (AISI/PVC)

- Filtri di aspirazione
  - Connessioni 3/8" - 1/2" - 3/4" - 1"
- 
- Suction filters
  - Connections 3/8" - 1/2" - 3/4" - 1"



### TF

- RACCORDI TUBI FLESSIBILI
  - Connessioni 3/8"-1/4"-1/2"-1" g.f. / 8x12
- 
- FLEXIBLE TUBE CONNECTORS
  - 3/8"-1/4"-1/2"-1" g.f. / 8x12

\*PVDF-C: Miscela di PVC e PVDF. Qualità meccaniche e chimiche superiori al PVC

\*PVDF-C: PVC and PVDF mixture. Mechanical and chemical properties higher than PVC



# TAURUS SERIES

POMPE DOSATRICI ELECTROMECCANICHE - ELECTROMECHANIC DOSING PUMPS

## ACCESSORI - ACCESSORIES

## Attuatore elettrico - Electric actuator



- Trasforma una pompa elettromeccanica in una pompa per il dosaggio proporzionale ad un segnale esterno, variandone la corsa, e quindi la portata in maniera automatica
- It transforms an electromechanic manual pump into a pump for a proportional dosing based on an external signal, by automatically adjusting the stroke length and therefore the flow rate

## Caratteristiche tecniche - Technical features

Corsa max - Max stroke	25 mm
Forza max - Max force	1300 N
Velocità max - Max speed	1 mm/Sec
Precisione - Accuracy	0,6 mm
Connessione cavi - Cable connections	2x3/4" NPT UNI6125
Opzioni - Options	1/2" UNI6125 - 1/2" & 3/4" UNI EN ISO 9864 - M 16X1,5 - M 20X1,5
Protezione - Protection	IP65
Peso - Weight	6 kg
Potenza nominale - Nominal power	25 mm
Alimentazione primaria/secondaria - Primary/secondary supply	110 ÷ 230 Vac, ±10%, 50/60Hz monofase - single-phase
Alimentazione ausiliaria - Auxiliary power supply	24 VDC (optional)
Segnale ingresso analogico - Analogue input signal	Standard 4 ÷ 20 mA ±1% / Impostabile - Settable 20 ÷ 20 mA ±1% / 0 ÷ 10V ±1% / 1 ÷ 50 Hz ±1%
Segnale ingresso digitale - Digital input signal	0÷5V In frequenza - In frequency 0,004 ÷ 50 Hz
Banda morta - Dead band	2% Modificabile - Modifiable
Segnale digitale - Digital signal	0÷5 VDC Contatto secco (interruttore remoto) - Dry contact (Remote switch)
Segnale consenso attuatore - Actuator content signal	100÷230 VAC, ±10%
Segnale uscita analogico - Analogue output signal	4÷20 VAC, ±10% F.S. su 500 Ohm (Fisso - Fixed)
Uscita collettore aperto - Open collector output	24 VDC - 50 mA max
Ciclo lavoro utile - Useful working cycle	Ciclo a modulazione illimitato - Unlimited modulation cycle



# ATLANTA SERIES

POMPA DI DOSAGGIO CON SISTEMA ELETTRONICO - DOSING PUMP WITH ELECTRONIC SYSTEM



## CARATTERISTICHE GENERALI / GENERAL FEATURES

- Dati cronologici e in tempo reale disponibili direttamente su qualsiasi dispositivo o PC collegato tramite Modbus, inclusi gli allarmi che aiutano a guidare un'efficace pianificazione della manutenzione e un rapido intervento tecnico
  - Ampio range di portate fino a 1000lt e pressioni fino a 10 bar
  - Alta precisione di dosaggio con regolazione digitale
  - Modalità di lavoro temporizzato, batch, manuale, proporzionale da segnali analogici o digitali
  - Possibilità di ruotare l'interfaccia digitale
  - Motori trifase a risparmio energetico, ampia gamma di materiali disponibili
- 
- Chronological and real-time data available directly on any device or PC connected via Modbus, including alarms that help manage an effective maintenance planning and a prompt technical intervention
  - Wide range of flow rates up to 1000lt and pressures up to 10 bar
  - High-precision dosing with digital adjustment
  - Operating mode: Timed, batch, manual or proportional (activation by analogue or digital signals)
  - Possibility to rotate the digital interface
  - Energy-saving three-phase motors, wide range of materials available

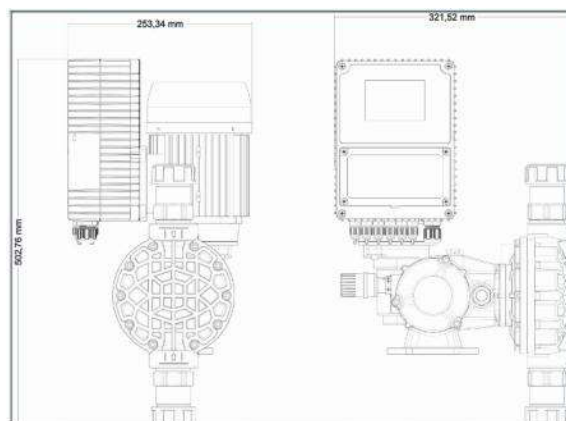



# ATLANTA SERIES

POMPA DI DOSAGGIO CON SISTEMA ELETTRONICO - DOSING PUMP WITH ELECTRONIC SYSTEM



Display innovativo - Innovative display

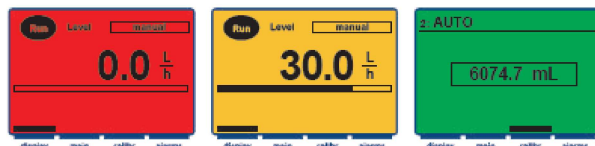

- Offre non solo opzioni in più lingue, ma cambia anche colore in base alla funzione operativa
- Multiple language option and colored background associated to the various operating functions

Materiali della testa della pompa - Pump head materials

- Ampia gamma di materiali SS-PVDF-PP
- Wide range of materials: SS-PVDF-PP



Posizione flessibile - Flexible position

Regolazione manuale della lunghezza della corsa  
Manual adjustment of stroke length

- Fornisce la massima precisione quando combinato con il dosaggio digitale del controller di Atlanta
- Controller e motore possono essere fissati in 3 posizioni per la massima flessibilità
- Provides the best accuracy when combined with the digital dosing of the Atlanta controller
- Controller and motor can be fixed in 3 positions guaranteeing the maximum flexibility

## CARATTERISTICHE IDRAULICHE - HYDRAULIC CHARACTERISTICS

TM02-04-06A/B/C POMPA A MEMBRANA DIAPHRAGM PUMP	TP15 POMPA A PISTONI PISTON PUMP	TP25 POMPA A PISTONI PISTON PUMP
Portata fino a 500 l/h Flow rate up to 500 l/h	Portata fino a 304 l/h Flow rate up to 304 l/h	Portata fino a 1000 l/h Flow rate up to 1000 l/h
Pressione massima fino a 16 bar Max pressure up to 16 bar	Pressione massima fino a 10 bar Max pressure up to 10 bar	Pressione massima fino a 20 bar Max pressure up to 20 bar
Colpi 1-116 - Strokes 1-116	Colpi 1-116 - Strokes 1-116	Colpi 1-116 - Strokes 1-116
Lunghezza della corsa 2-4-6 mm Stroke length 2-4-6 mm	Lunghezza della corsa 15 mm Stroke length 15 mm	Lunghezza della corsa 25 mm Stroke length 25 mm
Diaphragma di diametro fino a 165 mm Diameter diaphragm up to 165 mm	Pompa a pistoncini di diametro fino a 64 mm Diameter piston pump up to 64 mm	Pompa a pistoncini di diametro fino a 89 mm Diameter piston pump up to 89 mm
IP55 valutato - IP55 rated	IP55 valutato - IP55 rated	IP55 valutato - IP55 rated



# DOSING UNITS SERIES

GRUPPO DI DOSAGGIO - DOSING UNIT



DP 200

- **GRUPPO DI DOSAGGIO COMPOSTO DA:**
- Pompa **TAURUS (TAP/TAM)**
- Serbatoio 200, 300, 500, 1000 l.
- Supporto in PVC
- Kit accessori completo

• **DOSING UNIT COMPOSED OF:**

- **TAURUS (TAP/TAM)** pump
- 200, 300, 500, 1000 l. tank
- PVC support
- Complete accessories kit



DPM 200

- **GRUPPO DI DOSAGGIO COMPOSTO DA:**
- Pompa **TAURUS (TAP/TAM)**
- Serbatoio 200, 300, 500, 1000 l.
- Supporto in PVC
- Agitatore MIX.1 T
- Gruppo aspirazione AC.LA
- Kit accessori completo

• **DOSING UNIT COMPOSED BY**

- **TAURUS (TAP/TAM)** pump
- 200, 300, 500, 1000 l. tank
- PVC support
- Mixer MIX.T 1
- Suction group AC.LA
- Complete accessories kit